



Lawrence Berkeley National Laboratory

Supervisory Controller for PV and Storage Microgrids

Michael Stadler¹, Salman Mashayekh¹, Sankar Narayanan²,
Nicholas DeForest¹, and Tobias Brandt³

¹Lawrence Berkeley National Laboratory, 1 Cyclotron Road, Berkeley,
CA 94720, USA

²Microgrid Labs, 957 Curtner Ave, San Jose, CA 95125

³University of Freiburg, Platz der Alten Synagoge, 79085 Freiburg, Germany

Lawrence Berkeley National Laboratory, Berkeley, CA

October 2015

The work described in this report was funded by the California Public Utilities Commission (CPUC) under California Solar Initiative Research, Demonstration and Deployment Program - Small Grant Solicitation. Development of previous versions of DER-CAM has been supported by the US Department of Energy under contract number DE-AC02-05CH11231.

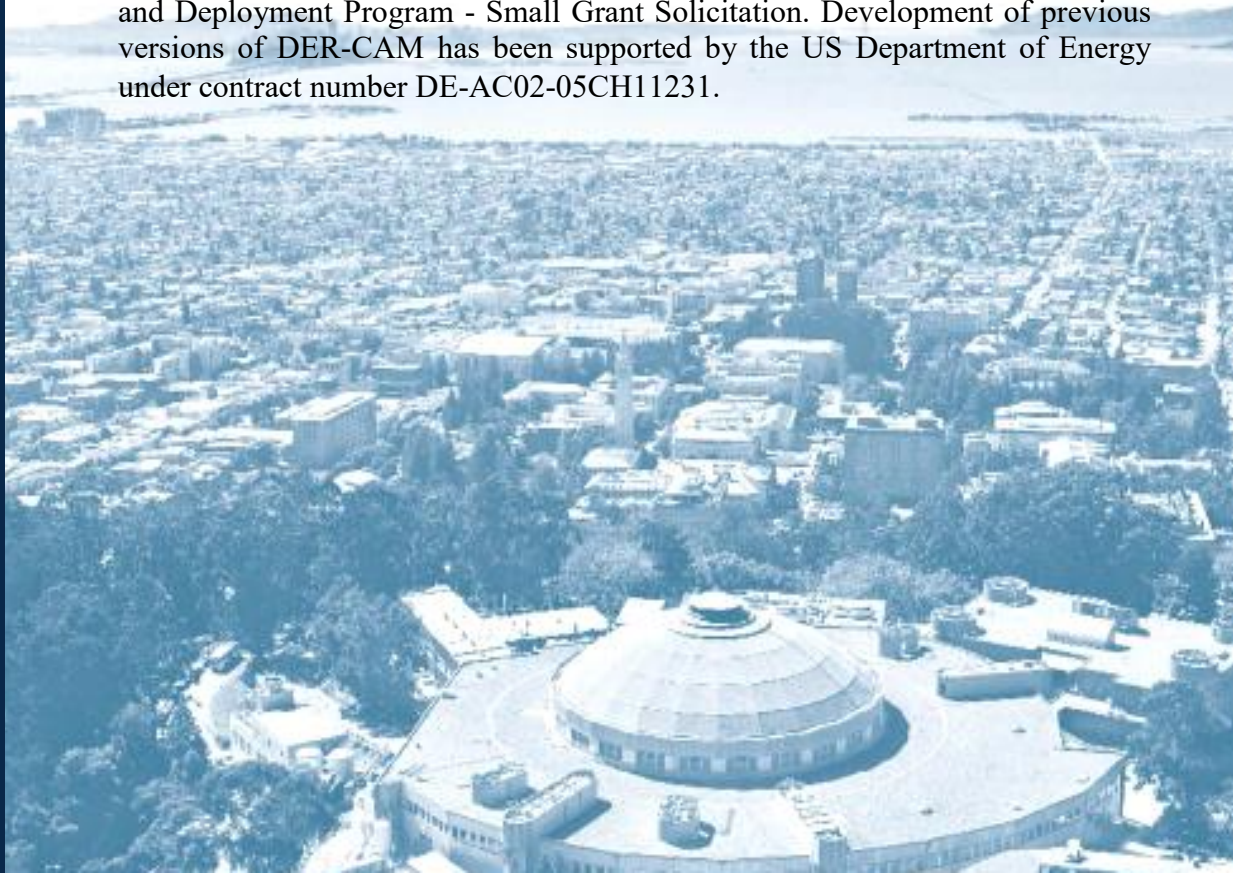

Disclaimer

This document was prepared as an account of work sponsored by the United States Government. While this document is believed to contain correct information, neither the United States Government nor any agency thereof, nor The Regents of the University of California, nor any of their employees, makes any warranty, express or implied, or assumes any legal responsibility for the accuracy, completeness, or usefulness of any information, apparatus, product, or process disclosed, or represents that its use would not infringe privately owned rights. Reference herein to any specific commercial product, process, or service by its trade name, trademark, manufacturer, or otherwise, does not necessarily constitute or imply its endorsement, recommendation, or favoring by the United States Government or any agency thereof, or The Regents of the University of California. The views and opinions of authors expressed herein do not necessarily state or reflect those of the United States Government or any agency thereof or The Regents of the University of California.

Final Project Report

Supervisory Controller for PV and Storage Microgrids

Prepared: October 6th, 2015

Project Lead: Tri-Technic

Project Partner: Berkeley Lab

*Authors: Michael Stadler, Salman Mashayekh, Sankar Narayanan,
Nicholas DeForest, Tobias Brandt*



DER-CAM DECISION SUPPORT TOOL FOR
DECENTRALIZED ENERGY SYSTEMS
ANALYTICS | PLANNING | OPERATIONS



Table of Contents

1	Introduction	3
2	Multi-Layered Microgrid Control System.....	4
3	Supervisory Controller Modules	5
3.1	PV Generation and Load Forecasting Module	6
3.2	Re-Optimization Module.....	8
3.3	Power Balancing Module	9
3.4	Data Exchange Module	11
3.4.1	DER-CAM to SCADA Data Exchange	11
3.4.2	SCADA to DER-CAM Data Exchange	13
4	Detailed Event Logging.....	14
5	A Full Day Operation Example of the Controller.....	16
6	Summary and Future Work.....	19
7	Acknowledgements.....	19

1 Introduction

The US Department of Defense has ambitious goals to increase renewable penetration in army installations. Microgrids can achieve this goal, and offer higher energy security, lower operating costs, and maximized renewable use. They can also enable a controllable resource that is capable of supporting local utilities or system operators by responding to Demand Response (DR) or ancillary service needs. Unlike diesel-based microgrids, control of renewable-intensive microgrids is challenging. Existing commercial microgrid controllers cannot interact directly with both building energy management systems and a diverse DER portfolio. They also do not have the forward-looking, analytical capability to optimally pursue strategies to reduce costs, maximize renewable utilization, operate in islanded mode for long periods, or maximize revenue from ancillary services or market participation.

This project intends to demonstrate some of the grid-connected features of the LBNL-proposed multi-layered microgrid control system at Fort Hunter Liggett (FHL)¹, an Army base in Monterey County, California. It shows the use of day-ahead optimization and real-time control to plan and implement charging/discharging schedules for this system that is comprised of 2 MW photovoltaic generation and 1 MWh electric storage. To achieve the goal of coordinated charging and discharging of the battery in order to increase the value from the PV installation, as well as to reduce the on-peak impact on the local utility, the supervisory controller schematically shown in Figure 1 was developed and deployed at FHL.

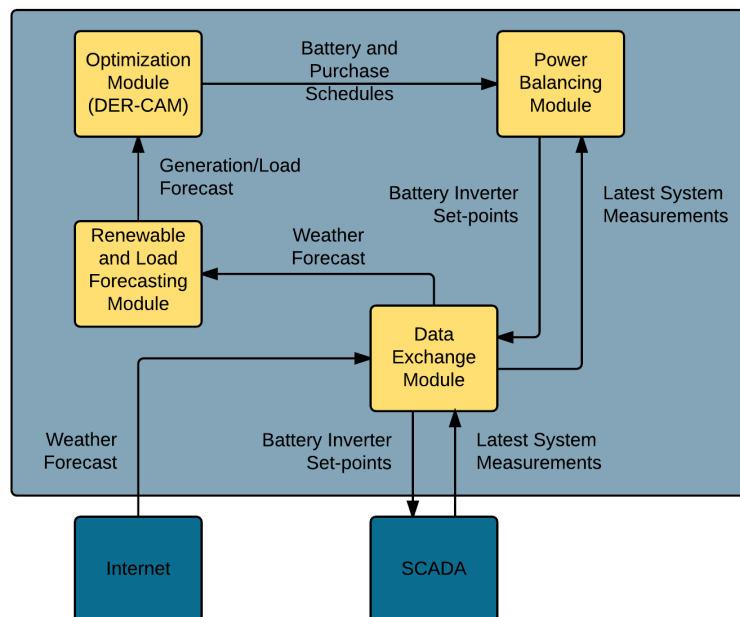

Figure 1: Supervisory controller structure. Scope of development in this project is shown in the top light blue box. SOC denotes state of charge.

The supervisory controller in this project demonstrates components of the LBNL multi-layered microgrid control system², particularly some of the modules from the supervisory control layer that focus on the

¹ Michael Stadler, Gregory Vallery: "Fort Hunter Liggett Microgrid Conversion," Military & Government Microgrids Summit, Hilton Arlington, Arlington, Virginia, 08-10 April, 2015.

² <https://building-microgrid.lbl.gov/projects/dynamic-control-microgrid-controller>

grid-connected operation of the microgrid. The demonstrated modules are the weather/renewable/load forecasting module, the DER-CAM optimization module, the power balancing module, and the data exchange module:

- a) The forecasting module develops forecasts for the loads and renewable generation for the next one to several days.
- b) The optimization module executes the Operations version of the LBNL-developed *Distributed Energy Resources Customer Adoption Model (Operations DER-CAM)* optimization, which generates day-ahead battery charging/discharging schedules for cost minimization.
- c) The data exchange module is the central communication interface with the existing Supervisory Control and Data Acquisition (SCADA) system from Siemens, which provides the computer/human interface and collects all needed data. The SCADA communicates with the battery system/inverter and passes on DER-CAM instructions. This project adds high level controller logic to the SCADA data collection system.
- d) The power balancing module balances the generation and load in the system to achieve the cost minimization target set by the optimization module. This module determines the difference between planned operation and actual observed conditions, and i) determines the best short-term solution to fulfill the cost targets; or ii) if the observed values deviate significantly from the forecast values, triggers a fresh re-optimization to determine the best operation strategy, using the latest observed values and updated forecasts.

2 Multi-Layered Microgrid Control System

The control system will follow an open multi-layered distributed architecture, in which control tasks will be distributed among four different layers, as depicted in Figure 2. In this architecture, layers one to four will be device level controls, network level controls, supervisory level controls, and grid interactive controls, respectively. The hardware layer shown in this figure at the bottom depicts microgrid hardware, including generation, load, and storage resources. The multi-layered control system will ensure stable, reliable, and optimized microgrid operation. This project demonstrates some of the grid-connected functionalities of the supervisory control layer (layer three).

Layer one will be a real-time device-level layer acting in the millisecond range that ensures stable and safe operation of the equipment and network. This layer will host controls such as switching devices (physical isolation, fault clearing), protection devices, inverters (voltage-frequency control), and primary frequency control (inverter and governor droops).

Layer two will be the network level automation and data acquisition layer acting in milliseconds to seconds range. It will include transition functions (e.g. re-synchronization and islanding detection), fast load shedding, load curtailment, network-level automation, and network level monitoring. It will also include functionalities like ramp rate controls and PV smoothing. Substation automation/SCADA systems are widely used in the industry to acquire and monitor data and to automate operations. This layer will be the main interface to the supervisory controller layer, layer 3, and enables the higher level controller to send commands to the apparatus. This approach makes the system easily scalable and extendable leveraging the existing data acquisition systems.

The fast controls in layers 1 and 2 form the backbone of the microgrid, and ensure its safe and stable operation in both grid-connected and islanded modes, as well as during transitions.

Layer three is the supervisory controller layer acting in timescales of one to several minutes that will optimize the operation of the system as a whole, in grid connected and islanded modes. It is based on LBNL’s DER-CAM microgrid optimization tool^{3,4}, and uses a Model Predictive Control (MPC) approach. In this approach, the optimization horizon is one day, and the optimization is run every 15 minutes, moving the optimization horizon forward by 15 minutes each time. This layer will host: forecasting (weather, load, and generation forecasting); data management (data logging, event recording, report creation); optimization (DER scheduling, CHP coordination, real-time adjustments); and others (PV imaging, PV smoothing, spinning reserve, secondary frequency control).

Layer four will be a grid interface layer that will support grid interactivity and allow data transfer between the utility/ISO and the microgrid. This layer will host grid interaction and analytics.

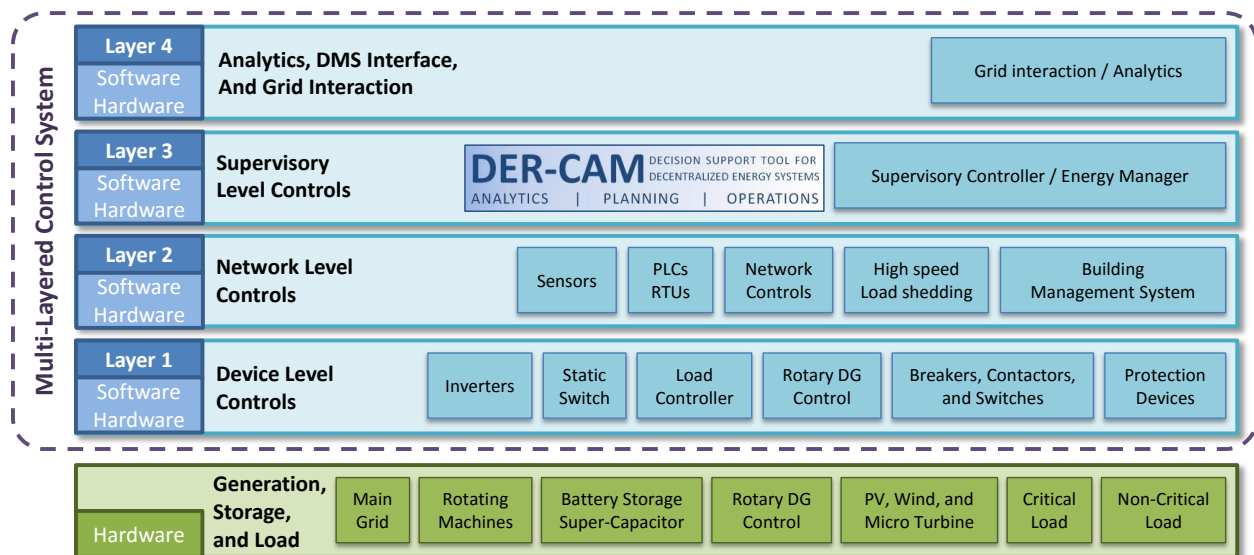

Figure 2. Multi-layered microgrid control system architecture, from DER hardware to supervisory control and grid interaction⁵. DMS stand for Distribution Management System.

3 Supervisory Controller Modules

A detailed diagram of the implemented supervisory controller at Fort Hunter Liggett is shown in Figure 3. This figure shows the data flow between the SCADA system and various modules of the supervisory controller. In summary, the SCADA system delivers the latest system measurements to the controller, and the controller stores the values in its database. The forecasting module uses the historic load and weather data, the latest measurements, and the weather forecast for the next 24 hours to estimate load demand and PV generation for the next 24 hours. The re-optimization module receives this information

³ Michael Stadler: “From DER Optimization to a Multi-Layered Microgrid Controller,” Infocast’s 5th Military & Commercial Microgrids Summit 2014, Pre-Summit Showcase, San Diego, California, 19 November 2014.

⁴ <https://building-microgrid.lbl.gov/projects/der-cam>

⁵ We want to thank the Electric Power Research Institute (EPRI) and Microgrid Labs for their support with this controller architecture.

and determines the optimum operation schedules for the next 24 hours using Operations DER-CAM. The optimum set-points are sent to the SCADA system to be implemented. The power balancing module reads the latest measurements, as well as the latest optimum set-points, from the controller database, and determines the best actions to compensate for the deviations from the forecasts. The best actions, i.e. the updated set-points, are then sent to the SCADA system to be implemented.

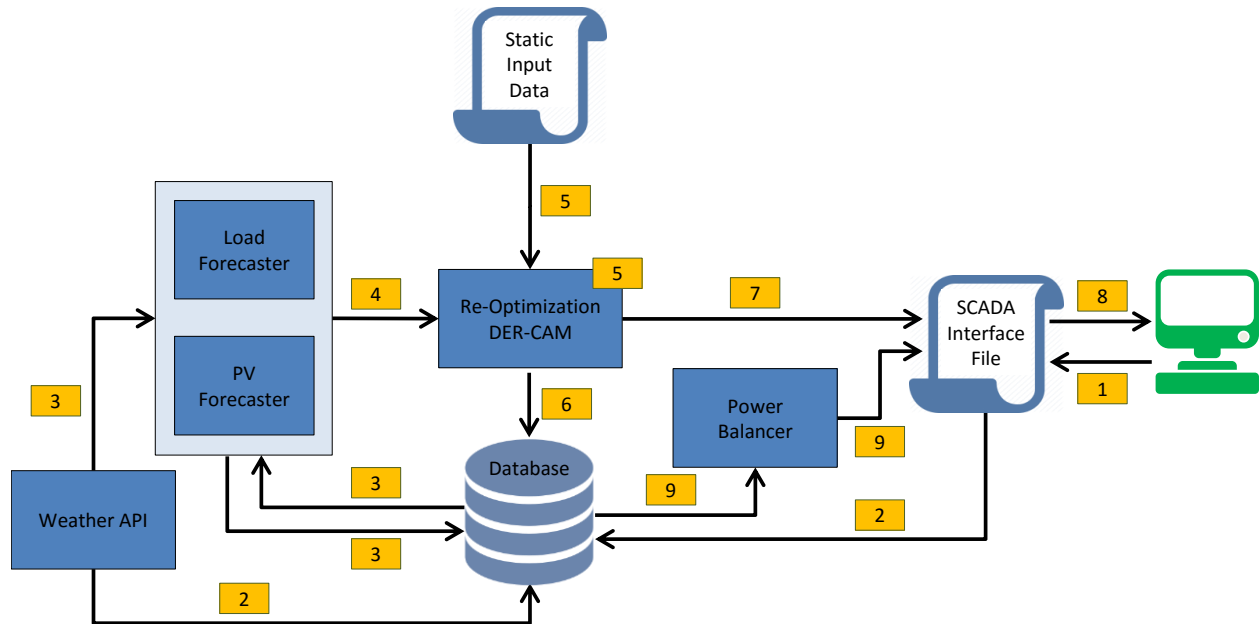

Figure 3. Supervisory controller implemented at Fort Hunter Liggett. Static input data includes equipment data and efficiency parameters. The numbers (in boxes) in this figure are associated with the controller log shown in Figure 9.

In the following subsections various modules of the controller are discussed in more detail.

3.1 PV Generation and Load Forecasting Module

Load forecasting: Since the loads are mainly driven by the number of troops present at Fort Hunter Liggett (between 0 and 4000), the loads can be very volatile and forecasting based on regression models is not an option. The load forecaster, developed within this project, is based on the Discrete Fourier Transformation, since the load curve shows very reliable patterns on a day-of-week basis. Building upon work by Hedwig et al.⁶, who use a Fast Fourier Transformation (FFT) to forecast Wikipedia workload, which exhibits similarly stable patterns, we employ a FFT-algorithm to forecast the energy load for the army base. This is illustrated in Figure 4(a) and (b). Figure 4(a) shows the demand curves for three successive Thursdays (blue) and the dominant frequencies that have been extracted by the FFT-algorithm (red). Figure 4(b) visualizes the fit between forecast (red) and actual load (blue) for the following Thursday.

⁶ M. Hedwig, S. Malkowski, and D. Neumann, "Towards Autonomics Cost-Aware Allocation of Cloud Resources," in *ICIS 2010 Proceedings*, St. Louis, MO, 2010.

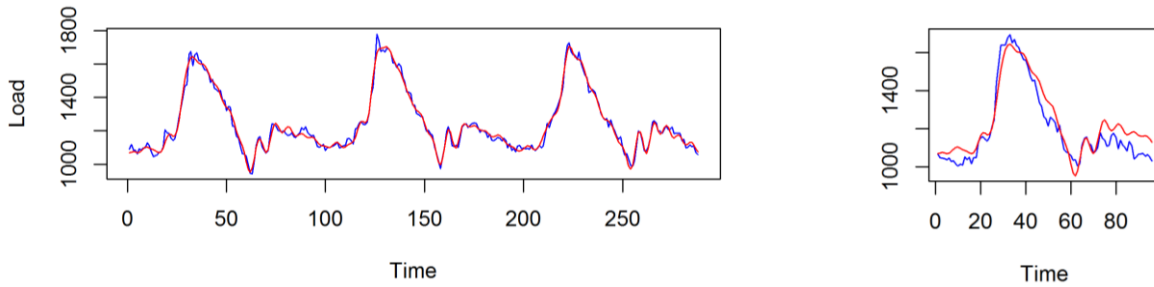

Figure 4. FFT algorithm to forecast FHL load: (a) Frequency extraction from historic dataset (left), (b) FFT Load Forecaster at FHL (right). For more information please see Brandt et al.⁷

While the fit is sufficiently good to serve as input for the optimizer, the occupancy of the base sometimes changes substantially for several weeks at a time. It would theoretically be possible to have an employee at the base provide information on the occupancy to the system, but this presents several organizational challenges. It requires work hours that cannot be spent on other issues. Also, occupancy of the base does not consistently translate to a certain increase or decrease of load, since it fundamentally depends on the activities of the occupants (e.g. computer-related vs. outdoor training). There is also the issue that a more detailed description of the occupants and their activities may be considered sensitive information that the facility would not want to be part of a microgrid operation information system.

To overcome this problem, we incorporated a learning parameter into the workload forecaster. Whenever deviations between forecast and actual load exceed a certain threshold for several successive periods, the part of the training dataset before these deviations started is scaled by a fraction of the average deviation. This decreases the immediate forecasting error if base occupancy has changed, while limiting the impact of random deviations that are not related to an occupancy change (false positives).

PV generation forecasting: The central assumption of forecasting PV generation is that power generated at a time on a clear day is directly related to the altitude of the sun above the horizon at that time. In the short term, this assumption is reasonable to provide a decent approximation, given the standard model by Masters⁸. In this project, this model is transformed and simplified such that it can be estimated by a linear regression – including the seasonal variables, which are assumed to be constant factors in the short term. Since the assumptions only hold in the short term, the training sample for the regression contains data of the most recent clear-sky daylight hours. If the interval to be forecasted contains points with cloudy or hazy weather, the clear-sky prediction is multiplied by a certain factor, depending on whether the forecasted weather is overcast (including rain/snow), partially clouded, or foggy.

⁷ Tobias Brandt, Nicholas DeForest, Michael Stadler, and Dirk Neumann: “Power Systems 2.0: Designing an Energy Information System for Microgrid Operation,” 2014 International Conference on Information Systems (ICIS 2014), December 14-17, 2014, Auckland, New Zealand, LBNL-6911E.

⁸ G.M. Masters, “Renewable and Efficient Electric Power Systems,” Wiley & Sons, Inc., Hoboken, NJ, 2004.

3.2 Re-Optimization Module

To develop the re-optimization module, the Operations version of the *Distributed Energy Resources Customer Adoption Model (DER-CAM)*, was adopted and enhanced by adding new features. The DER-CAM, designed by Lawrence Berkeley National Laboratory and developed in the Generalized Algebraic Modeling System (GAMS), is a flexible decision-support tool for decentralized energy systems. Two major versions of this tool are available: *Investment & Planning DER-CAM*, and *Operations DER-CAM*.

1. *Investment & Planning DER-CAM* determines the optimal investment portfolio of DERs based on cost and performance characteristics, tariff information, and historic/simulated hourly load and PV generation data, from a given building, campus, or microgrid.
2. *Operations DER-CAM* provides detailed optimized operation schedules for existing DERs in a building/microgrid on a week-ahead basis, using forecasted loads and weather data. Operations DER-CAM is capable of running in 1-hour, 15-minute, 5-minute, or 1-minute time steps.

DER-CAM is mathematically modeled as a Mixed Integer Linear Program^{9,10,11,12} and is based on the key premise that all thermal and electrical loads are served, although specific actions leading to load shedding can also be considered. Figure 5 shows a high-level schematic of the energy flow model used in DER-CAM in the form of a Sankey diagram.

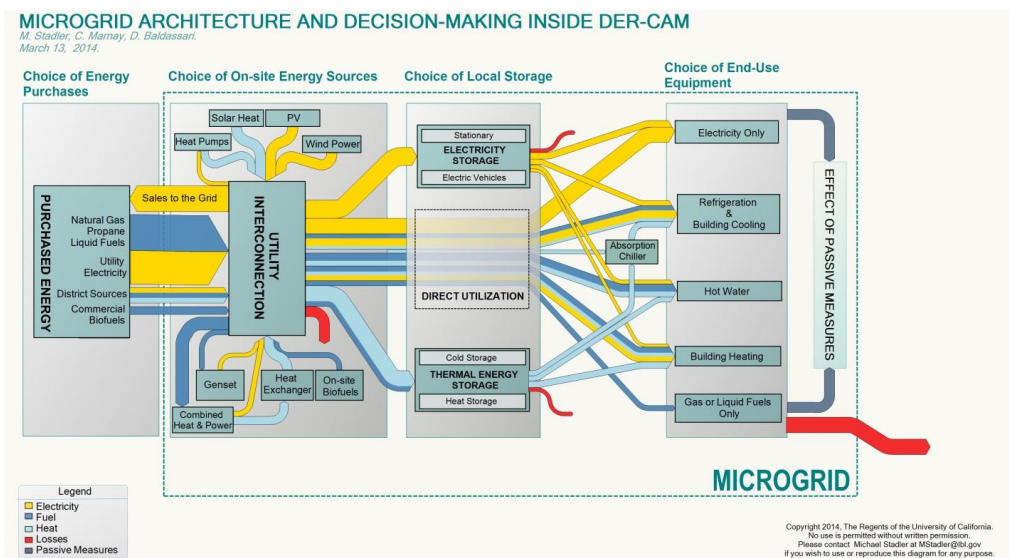

Figure 5. Schematic of the energy flow model used in DER-CAM.

⁹ G. Cardoso, M. Stadler, A. Siddiqui, C. Marnay, N. DeForest, A. Barbosa-Póvoa, and P. Ferrão, “Microgrid reliability modeling and battery scheduling using stochastic linear programming,” *Electric Power Systems Research*, vol. 103, pp. 61–69, 2013.

¹⁰ G. Cardoso, M. Stadler, M. C. Bozchalui, R. Sharma, C. Marnay, A. Barbosa-Póvoa, and P. Ferrão, “Optimal investment and scheduling of distributed energy resources with uncertainty in electric vehicle driving schedules,” *Energy*, vol. 64, pp. 17–30, 2014.

¹¹ M. Stadler, M. Kloess, M. Groissböck, G. Cardoso, R. Sharma, M. C. Bozchalui, and C. Marnay, “Electric storage in California’s commercial buildings,” *Applied Energy*, vol. 104, pp. 711–722, 2013.

¹² M. Stadler, M. Groissböck, G. Cardoso, and C. Marnay, “Optimizing distributed energy resources and building retrofits with the strategic DER-CAM model,” *Applied Energy*, vol. 132, pp. 557–567, 2014.

The enhanced formulation of the Operations DER-CAM has several distinctive features:

- The optimization start time is arbitrary and can be any time of the day.
- The optimization end time is arbitrary and can be any time of the day. Hence, the optimization horizon is arbitrary and is not restricted to integer numbers of days. This provides more flexibility to the controller.
- The optimization time step can be anything from one minute to one hour, which meets all of the needed controller functions.

The arbitrary start time feature enables the Operation DER-CAM to be used as the re-optimization module, which is called every 15 minutes, and determines the optimum operation schedules for the next 24 hours. If the forecasts are not available for an entire 24 hour period, the arbitrary end time/horizon features allow for optimization horizons that are shorter than a full day.

3.3 Power Balancing Module

The Power Balancing Module determines the required actions when the load/PV realizations deviate from the forecasted values, before the next DER-CAM optimization is run. To achieve this goal, the following two approaches were considered in this project:

Approach one, detailed state tree approach: In the first approach, the conditions during which the controller needs to make decisions, and the factors that possibly impact the decisions were exhaustively identified. The following conditions were identified:

- Over-generation, i.e. generation mismatch minus load mismatch is positive ($\Delta P_G - \Delta P_L > 0$)
- Under-generation, i.e. generation mismatch minus load mismatch is negative ($\Delta P_G - \Delta P_L < 0$)

The following three factors that could impact the best decision under each condition were identified, and several states for each factor were introduced:

- Time of day: (1) on-peak, (2) mid-peak, (3) off-peak
- State of charge: (1) low and close to the minimum acceptable state of charge, (2) high and close to the maximum acceptable state of charge
- Utility consumption: (1) exporting, (2) close to the maximum expected monthly demand (impacts the demand charge and utility costs), (3) lower than and not close to the maximum expected monthly demand

The state tree was developed, and best actions for each condition in each state were determined. This task can be translated into filling out the table shown below (Table 1). The suitable action for each condition, i.e. over- or under-generation, must be determined for each combination of recognized states, i.e. (time of day, utility consumption, state of charge).

State			Condition	
Time of Day	Utility Consumption	State of Charge	Over-Generation	Under-Generation
on-peak	close to max	low		
		high		
	lower than max	low		
		high		
	exporting	low		
		high		
mid-peak	lower than max	low		
		high		
	close to max	low		
		high		
	exporting	low		
		high		
off-peak	close to max	low		
		high		
	lower than max	low		
		high		
	exporting	low		
		high		

Table 1. State tree approach for power balancing.

Table 2 shows an effort to determine the best actions. This table shows the best actions when the microgrid is over-generating, and the system state is any of the possible combinations shown in Table 1. In this table, α , β , and γ denote the portion of the mismatch that goes into or is compensated by utility purchase, storage, and electricity export, respectively.

State			Condition
Time of Day	Utility Consumption	State of Charge	Over-Generation
on-peak or mid-peak or off-peak	lower than max	low	a combination of utility consumption reduction and storage increase ($\alpha+\beta=1$)
		high	reduce the utility consumption ($\alpha=1$)
	close to max	low	store the extra energy ($\beta = 1$)
		high	store as much as possible, then reduce util. cons. (maximize β , then use α)
	exporting	low	export the extra ($\gamma = 1$)
		high	export the extra ($\gamma = 1$)

Table 2. State tree approach for power balancing – Example actions.

According to this table, during an over-generation condition:

- If the microgrid is importing electricity from the grid, and the utility demand is lower than the maximum expected monthly demand, and
 - If the battery state of charge is low, the power balancer will use the extra generation to reduce utility purchase and/or charge the battery, i.e. $\alpha + \beta = 1$.
 - If the battery state of charge is close to its maximum, the power balancer will use the extra generation to reduce utility purchase, i.e. $\alpha = 1$.
- If the microgrid is importing electricity from the grid, and the utility demand is close to the maximum expected demand, and
 - If the battery state of charge is low, the extra generation will be used to charge the battery, i.e. $\beta = 1$.

- If the battery state of charge is close to its maximum, the extra generation will be used to charge the battery to its maximum, and then reduce the utility purchase if possible, i.e. maximize β then use α .
- If the microgrid is exporting electricity to the grid, the extra generation will be exported.

The above approach to develop the power balancer rules is not straightforward and is challenging. There are going to be too many states, and determining the right action under each detailed state branch is not trivial. Also, the implementation of such detailed rules is difficult. Moreover, the overall benefit of this detailed approach, compared to a simpler, more straightforward approach may not be significant. Hence, a simpler power balancing approach was developed in this project, and is described below.

Approach two, simple high-level approach: In this approach, it is argued that the two important variables that significantly impact the operation cost and that need to be tracked closely with respect to the optimum values are the battery state of charge and the utility purchase. When the realizations deviate from the forecasts, the controller cannot track them simultaneously. In this approach, the scheduled value for the battery state of charge will be tracked and the utility purchase will be relaxed, unless the deviation from the scheduled purchase may result in extra demand charges. In this case, the battery set-point is adjusted and its optimum scheduled value is not tracked in order to avoid the extra demand charges.

3.4 Data Exchange Module

The data exchange module is the central communication interface with the existing Supervisory Control and Data Acquisition (SCADA) system from Siemens at FHL, which provides the computer/human interface and collects all needed data. Only the SCADA communicates with the battery system/inverter and passes on the DER-CAM instructions. This project adds high level controller logic to the SCADA system. By handling data communication with existing/commercially available Supervisory Control and Data Acquisition (SCADA), the configuration allows for an open and inexpensive platform for the supervisory controller, increasing the potential market size and impact. The SCADA will distribute the controller signals to the technologies or interface with the Building Management System (BMS) to perform the supervisory instructions. Thus, the SCADA needs to collect all the information needed for the optimization and provide it to the controller.

3.4.1 DER-CAM to SCADA Data Exchange

In this project, the data that needs to be provided by the SCADA is defined. A plain Comma Separated Value (CSV) file is used as the data transfer format. The CSV file format is favored by some industry partners since it is a robust way to exchange data. Figure 6 shows an example of the DER-CAM/SCADA interface file. As shown in this figure, this file includes the optimum dispatch prepared for the day at 12:00 am, the latest rolling optimum dispatch (that is carried out every 15 minutes), and the optimum set-points for the inverter which must be used during the next 15 minutes. The SCADA system sends the set-points for the next 15 minutes to the battery inverters. The SCADA system receives the day-ahead and rolling dispatches for two purposes:

- they are used for visualization purposes, and

- they may also be used as the optimum set-points to be sent to the inverters, in case the link between the optimization module and the SCADA system breaks and the SCADA does not receive updated dispatches from the optimization module.

Figure 7 shows how the day-ahead and rolling horizon optimum dispatch schedules are displayed by the SCADA system.

	A	B	C	D	E	F	G	H
1								Weather forec
2	EMS - SCADA (Instructions)							Comment:
3	UPDATE COMPLETED BY EMS		0					
4	<u>Description</u>	<u>from</u>	<u>to</u>	<u>Value</u>				
5	<u>Day Ahead Scheduling (DHS) for viewing purposes ONLY.</u> <u>this schedule will be provided by the EMS once a day</u>							
6	Inverter 1 for battery 1- active power - forecast	EMS	SCADA	0.000	0.000	0.000	0.000	0.000
7	Inverter 2 for battery 2 - active power - forecast	EMS	SCADA	0.000	0.000	0.000	0.000	0.000
8	PV inverter 1 - active power - forecast	EMS	SCADA	0.000	0.000	0.000	0.000	0.000
9	PV inverter 2 - active power - forecast	EMS	SCADA	0.000	0.000	0.000	0.000	0.000
10	PV inverter 3 - active power - forecast	EMS	SCADA	0.000	0.000	0.000	0.000	0.000
11	PV inverter 4 - active power - forecast	EMS	SCADA	0.000	0.000	0.000	0.000	0.000
12	Load - forecast	EMS	SCADA	0.000	0.000	0.000	0.000	0.000
13								
14	<u>Rolling Scheduling (RS) for statistics ONLY.</u> <u>will be updated by EMS every 15mins</u>							
15	Inverter 1 for battery 1- active power - updated forecast	EMS	SCADA	0.000	0.000	0.000	0.000	0.000
16	Inverter 2 for battery 2 - active power - updated forecast	EMS	SCADA	0.000	0.000	0.000	0.000	0.000
17	PV inverter 1 - active power - updated forecast	EMS	SCADA	0.000	0.000	0.000	0.000	0.000
18	PV inverter 2 - active power - updated forecast	EMS	SCADA	0.000	0.000	0.000	0.000	0.000
19	PV inverter 3 - active power - updated forecast	EMS	SCADA	0.000	0.000	0.000	0.000	0.000
20	PV inverter 4 - active power - updated forecast	EMS	SCADA	0.000	0.000	0.000	0.000	0.000
21	Load - updated forecast	EMS	SCADA	0.000	0.000	0.000	0.000	0.000
22								
23	<u>Actual Setpoints and ONLY these ones will be used for the technology set-points</u>					<u>ORIGINAL SOURCE</u>	<u>DESTINATION</u>	
24	Inverter 1 for battery 1- active power - set point	EMS	SCADA	0.000	KW value	EMS	Battery Inverter1	
25	Inverter 1 for battery 1- reactive power - set point	EMS	SCADA	0.000	KVAR value	EMS	Battery Inverter1	
26	Inverter 2 for battery 2 - active power - set point	EMS	SCADA	0.000	KW value	EMS	Battery Inverter2	
27	Inverter 2 for battery 2 - reactive power - set point	EMS	SCADA	0.000	KVAR value	EMS	Battery Inverter2	
28	PV inverter 1 - active power set point	EMS	SCADA	0.000	KW value	EMS	PV Inverter1	
29	PV inverter 1 - POWER FACTOR set point	EMS	SCADA	0.000	KVAR value	EMS	PV Inverter1	
30	PV inverter 2 - active power set point	EMS	SCADA	0.000	KW value	EMS	PV Inverter2	
31	PV inverter 2 - POWER FACTOR set point	EMS	SCADA	0.000	KVAR value	EMS	PV Inverter2	
32	PV inverter 3 - active power set point	EMS	SCADA	0.000	KW value	EMS	PV Inverter3	
33	PV inverter 3 - POWER FACTOR set point	EMS	SCADA	0.000	KVAR value	EMS	PV Inverter3	
34	PV inverter 4 - active power set point	EMS	SCADA	0.000	KW value	EMS	PV Inverter4	
35	PV inverter 4 - POWER FACTOR set point	EMS	SCADA	0.000	KVAR value	EMS	PV Inverter4	
36	Load set point	EMS	SCADA	0.000	KW value	EMS	SCADA - Display only	
37								
38	<u>PV on/off commands</u>							
39	PV inverter 1 - ON	EMS	SCADA	0	ON/OFF	EMS	PV Inverter1	
40	PV inverter 1 - OFF	EMS	SCADA	0	ON/OFF	EMS	PV Inverter1	
41	PV inverter 2 - ON	EMS	SCADA	0	ON/OFF	EMS	PV Inverter2	
42	PV inverter 2 - OFF	EMS	SCADA	0	ON/OFF	EMS	PV Inverter2	
43	PV inverter 3 - ON	EMS	SCADA	0	ON/OFF	EMS	PV Inverter3	
44	PV inverter 3 - OFF	EMS	SCADA	0	ON/OFF	EMS	PV Inverter3	
45	PV inverter 4 - ON	EMS	SCADA	0	ON/OFF	EMS	PV Inverter4	
46	PV inverter 4 - OFF	EMS	SCADA	0	ON/OFF	EMS	PV Inverter4	
47								

Figure 6. DER-CAM to SCADA data exchange file.

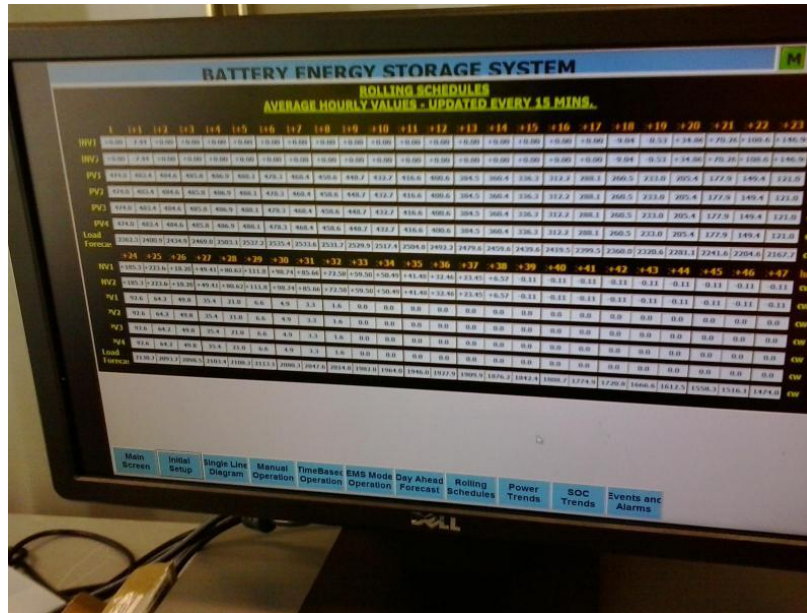

Figure 7. SCADA monitor showing instructions for smart storage inverters based on DER-CAM.

3.4.2 SCADA to DER-CAM Data Exchange

The SCADA system collects measurements throughout the entire distributed system. A subset of the measurements that is needed by the controller was identified in this project. This data is transferred through a CSV file, generated by the SCADA system, and read by our controller. An example for this data file is depicted in Figure 8. As shown in this figure, this data includes battery state of charge, battery inverter power, PV generation, and power readings from the point of common coupling.

SCADA - EMS Initial values SCADA will update these values every minute for EMS						
UPDATE COMPLETED BY SCADA		0				
Description	from	to	Value	type	original source	
Inverter 1 - active power - actual	SCADA	EMS	0.0000	KW value	Inverter	
Inverter 1 - reactive power - actual	SCADA	EMS	0.0000	KVAR value	inverter	
Inverter 1 - active power - limit	SCADA	EMS	0.0000	KW value	SCADA	from Initial Setup
Inverter 2 - active power - actual	SCADA	EMS	0.0000	KW value	inverter	
Inverter 2 - reactive power - actual	SCADA	EMS	0.0000	KVAR value	inverter	
Inverter 2 - active power - limit	SCADA	EMS	0.0000	KW value	SCADA	from Initial Setup
Battery 1- State of charge	SCADA	EMS	0	SOC %	Battery	
Battery 2- State of charge	SCADA	EMS	0	SOC %	Battery	
Battery 1- Pack max discharge current limit	SCADA	EMS	0	Ampere value	Battery	
Battery 1- Pack max continuous charge current limit	SCADA	EMS	0	Ampere value	Battery	
Battery 2- Pack max discharge current limit	SCADA	EMS	0	Ampere value	Battery	
Battery 2- Pack max continuous charge current limit	SCADA	EMS	0	Ampere value	Battery	
12.5 KV Circuit breaker - ON status	SCADA	EMS	FALSE	ON/OFF	12kv cb relay	
12.5 KV Circuit breaker - OFF status	SCADA	EMS	FALSE	ON/OFF	12kv cb relay	
PCC Circuit breaker - ON status	SCADA	EMS	FALSE	ON/OFF	PCC CB relay	
PCC Circuit breaker - OFF status	SCADA	EMS	FALSE	ON/OFF	PCC CB relay	
Inverter 1 ON/OFF	SCADA	EMS	FALSE	ON/OFF	inverter	
Inverter 2 ON/OFF	SCADA	EMS	FALSE	ON/OFF	inverter	
PV inverter 1 - ON status	SCADA	EMS	FALSE	ON/OFF	PV SCADA	
PV inverter 1 - OFF status	SCADA	EMS	FALSE	ON/OFF	PV SCADA	
PV inverter 2 - ON status	SCADA	EMS	FALSE	ON/OFF	PV SCADA	
PV inverter 2 - OFF status	SCADA	EMS	FALSE	ON/OFF	PV SCADA	
PV inverter 3 - ON status	SCADA	EMS	FALSE	ON/OFF	PV SCADA	
PV inverter 3 - OFF status	SCADA	EMS	FALSE	ON/OFF	PV SCADA	
PV inverter 4 - ON status	SCADA	EMS	FALSE	ON/OFF	PV SCADA	
PV inverter 4 - OFF status	SCADA	EMS	FALSE	ON/OFF	PV SCADA	
PV inverter 1 - KW - actual	SCADA	EMS	0.0000	KW value	PV SCADA	
PV inverter 1 - KVAR - actual	SCADA	EMS	0.0000	KVAR value	PV SCADA	
PV inverter 2 - KW - actual	SCADA	EMS	0.0000	KW value	PV SCADA	
PV inverter 2 - KVAR - actual	SCADA	EMS	0.0000	KVAR value	PV SCADA	
PV inverter 3 - KW - actual	SCADA	EMS	0.0000	KW value	PV SCADA	
PV inverter 3 - KVAR - actual	SCADA	EMS	0.0000	KVAR value	PV SCADA	
PV inverter 4 - KW - actual	SCADA	EMS	0.0000	KW value	PV SCADA	
PV inverter 4 - KVAR - actual	SCADA	EMS	0.0000	KVAR value	PV SCADA	
Short term forecast from PV imaging - time stamps	SCADA	EMS		time value	PV SCADA	t1 t2
Short term forecast from PV imaging	SCADA	EMS		Irradiance forecast	PV SCADA	0.000 0.000
PCC P	SCADA	EMS	0.0000	KW value	PCC CB meter	
PCC Q	SCADA	EMS	0.0000	PF value	PCC CB meter	
PCC S	SCADA	EMS	0.0000	KVAR value	PCC CB meter	
12kv cb p	SCADA	EMS	0.0000	KW value	12kv cb meter	

Figure 8. SCADA to DER-CAM data exchange file.

4 Detailed Event Logging

The controller has been equipped with detailed event logging, in order to closely monitor the operation of the controller. The log displays warning and error messages in case information does not flow between various controller pieces as planned. A snapshot of the controller event logging, during a re-optimization, is shown in Figure 9. The events in the log are tagged with numbers (most left numbers) to correspond to the flow of information shown in the diagram of Figure 3.

```
(0) 2015-07-11 00:14:50: At this time a re-optimization is performed
(1) 2015-07-11 00:14:50: Connected to the SCADA server
(1) 2015-07-11 00:14:50: Current load information received from the SCADA interface
(1) 2015-07-11 00:14:50: Data file received from the SCADA interface
(2) 2015-07-11 00:14:50: Data inserted into the PV_weather database
(2) 2015-07-11 00:14:50: util_pur: 1278.826667, SOC: 0.250000, p_from_batt: 0.000000
(2) 2015-07-11 00:14:50: Data inserted into the Baseload database
(2) 2015-07-11 00:14:50: 15-min average for the baseload updated
(2) 2015-07-11 00:14:50: Data inserted into the load_weather_condition database
(3) 2015-07-11 00:14:50: PV and load forecast inserted in PV/load forecast tables
(4) 2015-07-11 00:14:50: Input file for the ODC optimization generated
(5) 2015-07-11 00:14:50: The optimization horizon is from 2015-07-11 00:15:00 to 2015-07-12 00:15:00
(5) 2015-07-11 00:14:50: ODC optimization was run and output file generated
(5) 2015-07-11 00:14:50: ODC output file was read
(5) 2015-07-11 00:14:50: Load-Elec-Only: 1302.92, E-from-Util: 1302.92, En-in-Batt: 250.00,
E-from-Batt: 0.00, E-to-Batt: 0.00, E-from-PV: 0.00, PV-onsite: 0.00,
PV-export: 0.00
(6) 2015-07-11 00:14:50: Optimum dispatch stored in the database
(7) 2015-07-11 00:14:50: Latest dispatch was read from opt-disp-load-elec-only, opt-disp-e-from-pv,
opt-disp-e-from-batt, opt-disp-e-to-batt, opt-disp-e-from-util tables
(7) 2015-07-11 00:14:50: Full day-ahead dispatch was read from opt-disp-load-elec-only,
opt-disp-e-from-pv, opt-disp-e-from-batt, opt-disp-e-to-batt,
opt-disp-e-from-util tables
(7) 2015-07-11 00:14:50: Local copy of the SCADA-EMS interface file was updated
(8) 2015-07-11 00:14:50: Connected to the SCADA server
(8) 2015-07-11 00:14:50: The SCADA interface file sent to the FHL server
```

Figure 9. Event logging in the implemented supervisory controller at Fort Hunter Liggett (re-optimization event).

Here is the sequence of events happening at time 00:14:50, in which a re-optimization is executed:

- 0) It shows that a re-optimization has been performed at this time.
- 1) The supervisory controller connects to the SCADA server, and receives the interface file including the latest system measurements, collected by the SCADA system.
- 2) The data is inserted into various tables in the controller’s database. This data will be used for load and weather forecasting.
- 3) The system load and PV are forecasted for next 24 hours. The forecasts are stored in the controller’s database.
- 4) The DER-CAM optimization input data file is prepared. It includes static input such as tariff and technology information, as well as dynamic input such as load and PV forecasts and battery state of charge.
- 5) The DER-CAM optimization is performed, and the optimization results are returned by GAMS in a CSV file. The optimization horizon is one day.
- 6) The optimization results are stored in the controller database.
- 7) The SCADA interface file is prepared, by pulling optimum dispatch information from the database.
- 8) The controller connects to the SCADA system and delivers the optimum schedules. The SCADA system will pass on these set-points to the battery inverters.

The optimization module is triggered every 15 minutes. To balance the system between two optimization runs, the power balancing module is run every minute. Figure 10 shows the events related to a power balancing event, happening at 07:16:50, which are described below:

- 0) It shows that a power balancing has been performed at this time.

- 1) The supervisory controller connects to the SCADA server and receives the interface file including the latest system measurements, collected by the SCADA system.
- 2) The data is inserted into various tables in the controller database. This data will be used for load and weather forecasting.
- 9) The power balancing module determines the best action to be performed, based on latest measurements. In the particular case shown in this event log:
 - The microgrid is importing electricity from the utility.
 - The power balancer intends to adjust the inverter set-point from -647.3 kW to -663.1 kW, in order to track the scheduled state of charge.
 - However, this change may lead to extra demand charges, since the electricity from the grid will exceed the expected maximum power demand for the current month.
 - Hence, the power balancer changes the inverter set-point to -654.0 kW, in order to avoid extra demand charges.
- 8) The controller connects to the SCADA system and delivers the updated inverter set-points. The SCADA system will pass on these set-points to the battery inverters.

```
(0) 2015-07-11 07:16:50: At this time a power balancing is performed
(1) 2015-07-11 07:16:50: Connected to the SCADA server
(1) 2015-07-11 07:16:50: Current load information received from the SCADA interface
(1) 2015-07-11 07:16:50: Data file received from the SCADA interface
(2) 2015-07-11 07:16:50: Data inserted into the PV_weather database
(2) 2015-07-11 07:16:50: util_pur: 1694.552822, SOC: 0.288168, p_from_batt: -647.315000
(2) 2015-07-11 07:16:50: Data inserted into the Baseload database
(2) 2015-07-11 07:16:50: 15-min average for the baseload and pv_weather tables updated
(2) 2015-07-11 07:16:50: Data inserted into the load_weather_condition database
(9) 2015-07-11 07:16:50: Tracking SOC, relaxing utility purchase
(9) 2015-07-11 07:16:50: Importing from the grid
(9) 2015-07-11 07:16:50: Adjusting inverter set-point (total) from -647.3 to -663.1 to track the optimum SOC
(9) 2015-07-11 07:16:50: Adjusting inverter set-point (total) from -663.1 to -654.0 to avoid extra demand charges
(9) 2015-07-11 07:16:50: Update file for the inverter set-points prepared
(8) 2015-07-11 07:16:50: Connected to the SCADA server
(8) 2015-07-11 07:16:50: The power balancer update file sent to the FHL server
```

Figure 10. Event logging in the implemented supervisory controller at Fort Hunter Liggett (power balancing event).

5 A Full Day Operation Example of the Controller

A full day operation of the supervisory controller is depicted in Figure 11. In this figure, subplots (from top to down) show the PV generation, load demand, battery state of charge, battery inverter power in kilowatts, and electricity import from the utility, respectively. Each subplot includes the following 6 waveforms:

- Dispatch at 00:00 (red line): This waveform shows the results from the optimization carried out at 12 am. The optimization horizon covers midnight to midnight.
- Dispatch at 06:00, 12:00, and 18:00 (dashed lines): These three waveforms show the optimum dispatches from the re-optimization module, carried out at 6am, 12pm, and 6pm, respectively. These three were arbitrarily chosen from among the 96 re-optimization runs that happened during the one day operation to demonstrate how the optimum schedules change during the day based on latest measurements and forecasts.

- Rolling dispatch (blue line): From each re-optimization run, only the first set-point (i.e. the set-point for the next 15 minutes) is applied to the system, and the next ones are overwritten by the next re-optimization runs. The waveform denoted with rolling dispatch shows these set-points that were sent to the system apparatus.
- Measurement (green): This waveform shows the measurement value, or the realized value, for each variable.

Figure 11 for the PV generation shows that the PV forecasts that happen before 6:30 am are not very accurate, since they are entirely based on historic information from previous days. However, starting from 6:30 am, the forecasts become much more accurate, since they also take into account the measured PV generation of the current day. The waveforms for dispatch at 12:00 and 18:00, as well as the waveform for the rolling dispatch, validate this observation. Similarly, Figure 11 for the total load shows that as the day progresses, the load forecasts become more accurate, since more and more load measurements from the current day are taken into consideration in the forecasting module.

Figure 11 for the battery SOC shows that initially, the controller planned to fully charge the battery by 8am, then discharge the battery slightly before re-charging it to 100% by 2pm, and then fully discharging it during afternoon peak hours. However, since the available PV generation was more than initially expected, this plan changed during the day. In what was finally implemented, the battery went through a full charge/discharge cycle for the morning peak hours and another cycle for the afternoon peak hours.

Figure 11 for the battery inverters shows the set-point provided by the re-optimization, as well as the adjusted set-point provided by the power balancing module, which now match the measurements. The difference between these two set-points are the power balancing module adjustments, which intend to track the scheduled state of charge, without causing any additional demand charges. Figure 11 for the battery SOC shows that the battery state of charge closely tracks the optimum scheduled values, thanks to the power balancing module inverter set-point adjustments.

Figure 11 for the utility power shows the expected amount of electricity import from the grid at different times of the day, as well as the measured values. This figure shows that although the load demand is higher than the expected/forecasted value at most time steps (see Figure 11 for the total load), the electricity import from the grid does not significantly exceed the expected values, thanks to the power balancing module's logic that intends to limit extra demand charges caused by PV/load deviations from the forecasted values.

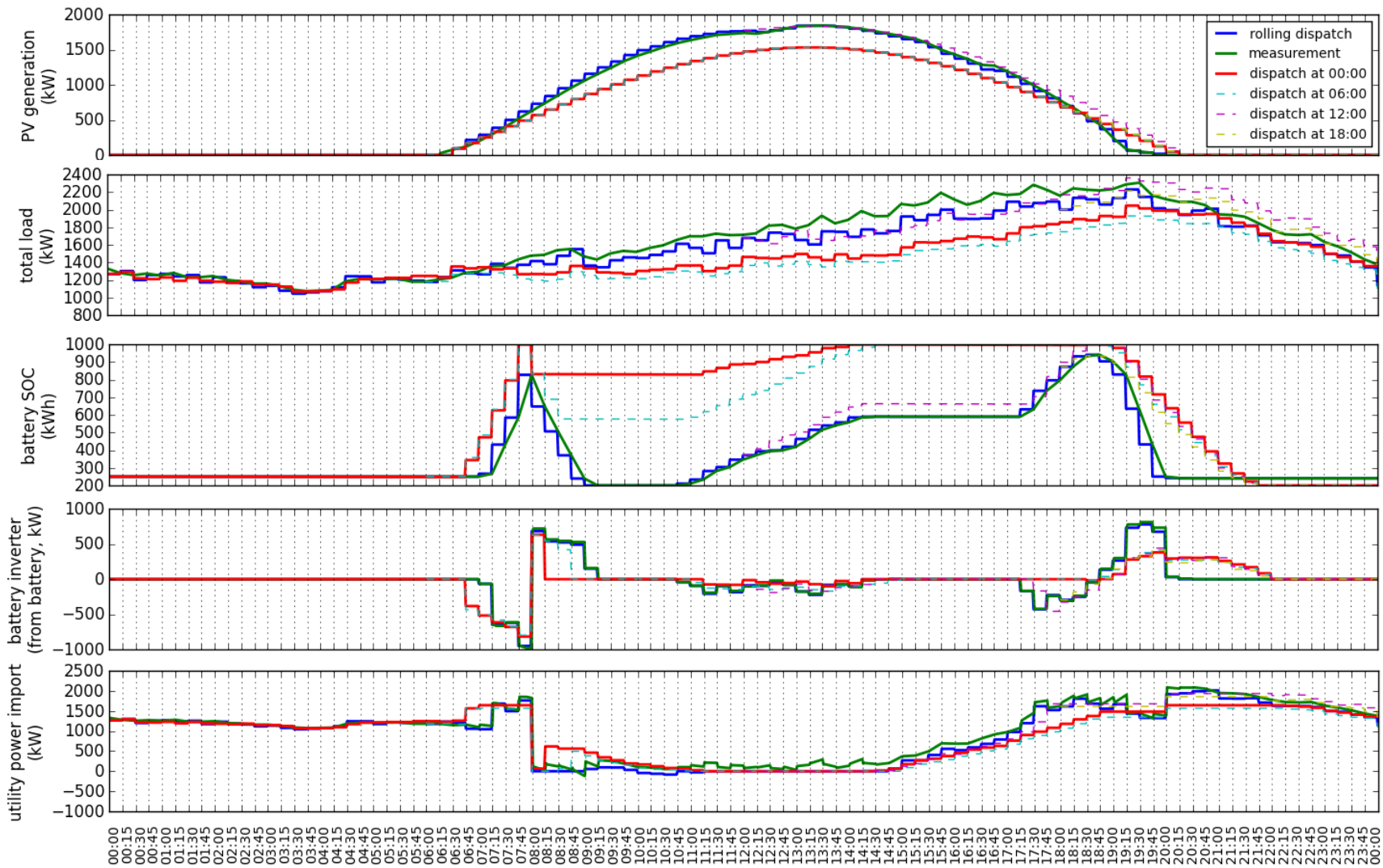

Figure 11. A full day operation of the controller. From top to bottom: PV generation (kW), total system load (kW), battery state of charge (kWh), battery inverter power (kW), and electricity import from the utility grid (kW).

6 Summary and Future Work

This project demonstrated some functionalities of the LBNL-proposed multi-layered microgrid control system, to control the PV/battery system at Fort Hunter Liggett, an army base in California. Specifically, the focus of the project was on the supervisory layer of the control system, by developing/deploying the following modules:

- The forecasting module that forecasts load and renewable generation for the next one to several days.
- The optimization module that determines the day-ahead battery charging/discharging schedules for cost minimization, based on the Operations DER-CAM optimization.
- The data exchange module that is the communication interface with the existing Supervisory Control and Data Acquisition (SCADA), through which the measurements are received and the set-points are sent to the battery inverters.
- The power balancing module that balances the generation and load in the system between two optimization runs, in order to achieve the cost minimization target set by the optimization module.

Future work will include exhaustive operation data collection to evaluate the performance of the supervisory controller, and make further enhancements.

7 Acknowledgements

The work described in this report was funded by the California Public Utilities Commission (CPUC) under California Solar Initiative Research, Demonstration and Deployment Program - Small Grant Solicitation. Development of previous versions of DER-CAM has been supported by the US Department of Energy under contract number DE-AC02-05CH11231.

The authors thank the CPUC for funding this project and the Department of Defense for providing the test site, Fort Hunter Liggett. The authors also acknowledge all those who assisted in this project, especially Gregory Vallery and Todd Dirmeyer.